



MODEL NUMBER	PACKAGING	RoHS STATUS
142-0711-201	25/BAG BULK PACK	RoHS
142-0711-202	500 PCS. TAPE & REEL w/.005 THK COVER TAPE PER FIG 1	
142-0711-205 	25/BAG BULK PACK	NON-RoHS
142-0711-206 	500 PCS. TAPE & REEL w/.005 THK COVER TAPE PER FIG 1	



NOTES: UNLESS OTHERWISE SPECIFIED.

1. MATERIAL & FINISH:

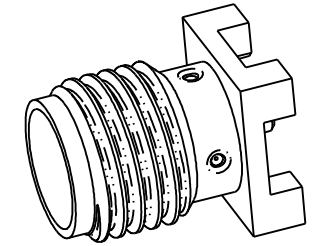
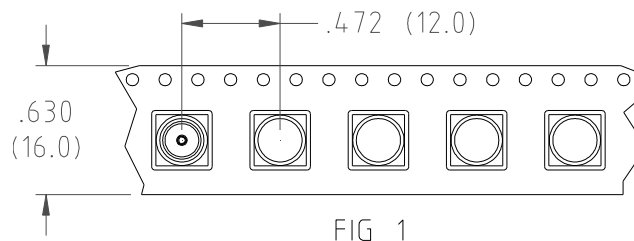
- 1.1 BODY:
  - 1.1.1 142-0711-201 & -202: GOLD PLATED BRASS
  - 1.1.2 142-0711-205 & -206: NICKEL PLATED BRASS
- 1.2 DIELECTRIC: PTFE (TEFLON)
- 1.3 CENTER CONTACT: GOLD PLATED BERYLLIUM COPPER

2. ELECTRICAL:

- 2.1 IMPEDANCE: 50 OHMS
- 2.2 FREQUENCY RANGE: 0-18 GHz
- 2.3 WORKING VOLTAGE: 335 VRMS MAX AT SEA LEVEL
- 2.4 DIELECTRIC WITHSTANDING VOLTAGE: 1000 VRMS MIN AT SEA LEVEL
- 2.5 INSULATION RESISTANCE: 5000 MEGOHM MIN
- 2.6 CONTACT RESISTANCE:
  - 2.6.1 CENTER CONTACT: INITIAL 3.0 MILLIOHM MAX, AFTER ENVIRONMENTAL 4.0 MILLIOHM MAX.
  - 2.6.2 OUTER CONDUCTOR: INITIAL 2.0 MILLIOHM MAX
- 2.7 CORONA LEVEL: 250 VOLTS MIN AT 70,000 FEET
- 2.8 RF HIGH POTENTIAL WITHSTANDING VOLTAGE: 670 VRMS MIN AT 4 & 7 MHz

3. MECHANICAL:

- 3.1 ENGAGE/DISENGAGE TORQUE: 2 IN-LBS MAX
- 3.2 MATING TORQUE: 7-10 IN-LBS
- 3.3 CONTACT RETENTION: 6 LBS MIN AXIAL FORCE, 4 IN-OZ MIN RADIAL TORQUE
- 3.4 DURABILITY: 500 CYCLES MIN.

4. ENVIRONMENTAL: (MEETS OR EXCEEDS THE APPLICABLE PARAGRAPH OF MIL-PRF-39012)

- 4.1 THERMAL SHOCK: MIL-STD-202, METHOD 107, CONDITION B
- 4.2 OPERATING TEMPERATURE: -65°C TO 165°C
- 4.3 CORROSION: MIL-STD-202, METHOD 101, CONDITION B
- 4.4 SHOCK: MIL-STD-202, METHOD 213, CONDITION I
- 4.5 VIBRATION: MIL-STD-202, METHOD 204, CONDITION D
- 4.6 MOISTURE RESISTANCE: MIL-STD-202, METHOD 106.

 BOTTOM OF CONNECTOR MOUNTING PADS PRE-TINNED WITH 60%/40% TIN/LEAD SOLDER.

 LAND PATTERN FOR REFERENCE ONLY. PATTERN MAY VARY DEPENDING ON ASSEMBLY PROCESS, BOARD TYPE OR SPECIFIC ELECTRICAL OR MECHANICAL REQUIREMENTS.

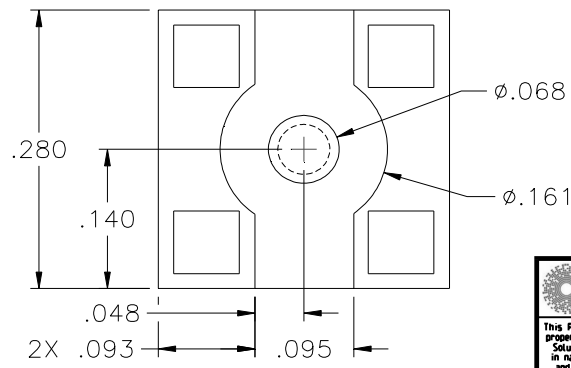
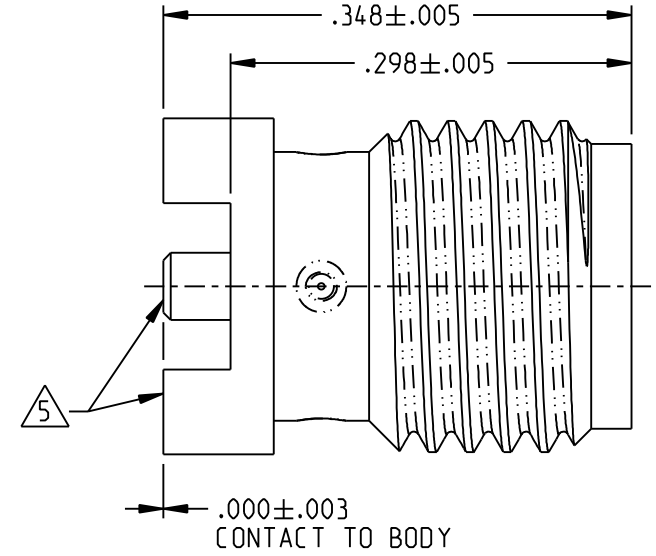
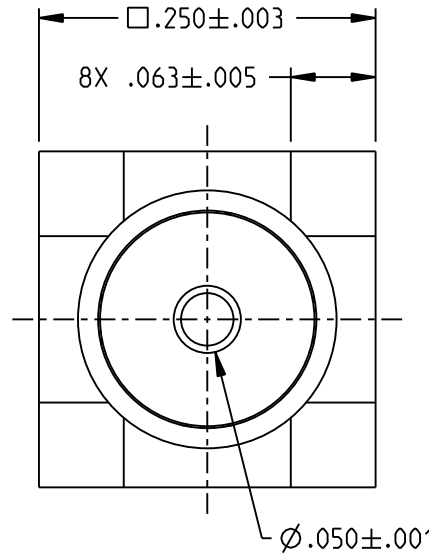

RECOMMENDED LAND PATTERN 

	3RD ANGLE PROJECTION	<b>JOHNSON</b>	
	SEE TABLE	Title:	JACK ASSEMBLY STRAIGHT PC SURFACE MOUNT SMA
<small>This PROPRIETARY Document is property of Cinch Connectivity Solutions. It is confidential in nature, non-transferable, and issued with the clear understanding that it is not traced or copied without permission and is returnable upon demand.</small>	UNLESS OTHERWISE SPECIFIED UNITS: INCH	Model No.	142-0711-201/210
	.XX ± .02 .XXX ± .010 ANGLES ± 2°	Size	A
INTERPRET DRAWING IN ACCORDANCE WITH ASME Y14.5-2009.	DO NOT SCALE DRAWING	Date:	6/23/2017
		Sheet	1 OF 1

# Mouser Electronics

Authorized Distributor

Click to View Pricing, Inventory, Delivery & Lifecycle Information:

[Cinch Connectivity Solutions:](#)

[142-0711-202](#)